

KELLER - Abstandhalter / Seilsysteme K-fix

KELLER - Fixations / Systèmes de cable K-fix



Perfektes Design, ausgereifte Funktionalität und bestes Material - das alles zeichnet die Befestigungsdrehteile von KELLER K-fix aus. Die Einsatzbereiche sind so vielfältig wie die Formen, Masse und Ausführungen. Im Innen- und Aussenbereich setzen unsere Befestigungssysteme Akzente und halten alles, was sie versprechen.

Design parfait, fonctionnalité maximale et des matériaux excellents - ce sont les caractères des pièces tournées de fixations de KELLER K-fix. L'utilisation est varié ainsi que des formes, des mesures et des exécutions. Nos systèmes de fixations donnent des orientations et tiennent la promesse à l'intérieur et l'extérieur.

KELLER - Abstandhalter K-fix KELLER - fixations K-fix

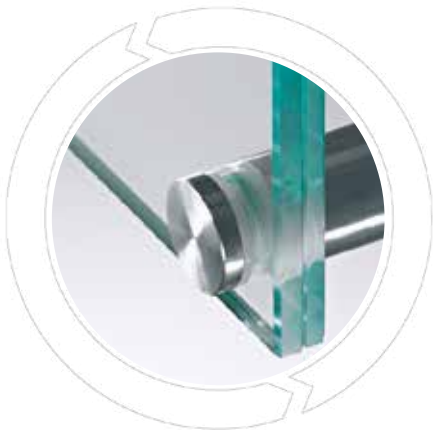

De la technique simple et de style - Elle est ce qui différencie les fixations KELLER K-fix des autres systèmes existants. L'utilisation des différents matériaux de base et la grande qualité apportée à la réalisation de toutes nos fixations permettent un montage facile et rapide.

Lorsqu'il est impossible d'effectuer un montage au mur avec des entretoises, un haubannage entre le sol et le plafond peut être une alternative de style.

Les supports pour présentoirs de table complètent le large assortiment d'entretoises KELLER K-fix.



Einfache, stilvolle Technik - sie ist es, was die KELLER - Abstandhalter K-fix von anderen Systemen abhebt. Nicht nur die Verwendung von verschiedenen Grundmaterialien, sondern auch die überlegene Konstruktion bei allen Befestigungen ermöglicht eine einfache und zeitsparende Montage.

Ist eine Wandmontage mit Abstandhaltern nicht möglich, kann die Decken-Bodenverspannung eine ideale Alternative sein.

Halter für Tischaufsteller ergänzen das vielseitige Programm der KELLER - Abstandhalter K-fix.



Wir bieten Ihnen auch komplette Glas-Türschilder an - verlangen Sie unsere Unterlagen der Leit- und Orientierungssysteme FLORENZ









Nous vous proposons des plaques de porte en verre - demandez nos documentations de système signalétique FLORENZ.



KELLER - Abstandhalter K-fix

KELLER - Fixations K-fix

E 9

Abbildung dessin	VE unité	Artikelnummer no. d' article	Artikelbezeichnung description	Mat. Stärke épais. du mat.	Bohrung Ø perçage Ø	Wandabstand dist. mural	
	20	79.010.0123.71*	Abstandhalter Ø 10mm mit flachem Kopf, Sicherung mit seitlicher Imbusschraube, Unterteil ohne Kragen <i>entretoise Ø 10mm avec tête plate, protection avec vis latérale, partie inférieure sans col</i>	2 - 10mm	7mm	15mm	Ø 10  15
	20	79.015.0110.71*	Abstandhalter Ø 15mm mit flachem Kopf, Sicherung mit seitlicher Imbusschraube, Unterteil ohne Kragen, inkl. 2 Stk. Gummi- scheiben für Glasschutz <i>entretoise Ø 15mm avec tête plate, protection avec vis latérale, partie inférieure sans col, 2 pièces de caoutchouc incluses pour protection du verre</i>	1 - 11mm	8.5 - 9mm	18.5mm	Ø 15  18.5
	20	79.015.0103.71*	Abstandhalter Ø 15mm mit flachem Kopf, Sicherung mit seitlicher Imbusschraube, Unterteil mit Kragen, inkl. 2 Stk. Gummi- scheiben für Glasschutz <i>entretoise Ø 15mm avec tête plate, protection avec vis latérale, partie inférieure avec col, 2 pièces du caoutchouc incluses pour protection du verre</i>	3 - 10mm	10mm	18.5mm	Ø 15  18.5
	20	79.015.0107.71*	Abstandhalter Ø 15mm mit flachem Kopf, Sicherung mit seitlicher Imbusschraube, Unterteil mit Kragen, inkl. 2 Stk. Gummi- scheiben für Glasschutz <i>entretoise Ø 15mm avec tête plate, protection avec vis latérale, partie inférieure avec col, 2 pièces du caoutchouc incluses pour protection du verre</i>	3 - 10mm	10mm	40mm	Ø 15  40
	20	79.045.0103.87*	Unterlegscheibe mit Bund für Sandwich-Schilder 2x3mm <i>rondelle avec col pour plaques sandwich 2x3mm</i>				

*Ab Lager lieferbar

.71 = Edelstahl V2A
.87 = Kunststoff transparent







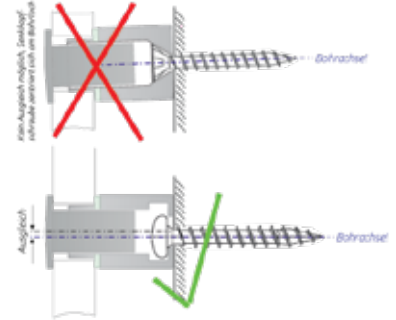

*livrable du stock

.71 = acier inoxydable V2A
.87 = mat. plastique transp.

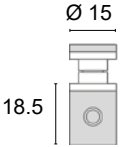
KELLER - Abstandhalter K-fix

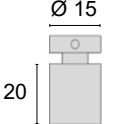
KELLER - Fixations K-fix

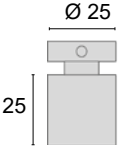
E 9

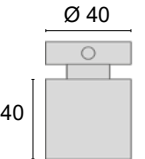
Abbildung dessin	VE unité	Artikelnummer no. d' article	Artikelbezeichnung description	Mat. Stärke épais. du mat.	Bohrung Ø perçage Ø	Wandabstand dist. mural	
	20	79.015.1511.71*	Abstandhalter Ø 15mm mit speziell flachem Kopf, Sicherung mit seitlicher Imbusschraube, Unterteil mit Kragen und spezielle Hohlkammer für Flachkopfschrauben (3.5x4.0mm) -> dadurch können Halter bei einem Rohrversatz eingerichtet werden. Inkl. 1 Stk. Gummischeibe für Glasschutz <i>entretoise Ø 15mm avec col particulièrement plat, protection avec vis latérale, partie inférieure avec col, cavité creuse pour vis à tête plate (3,5x4,0 mm), permettant le réglage précis des supports en présence d'un décalage du tube. 1 pièce du caoutchouc incluse pour protection du verre</i>	4 - 8mm	11mm	14mm	
	20	79.015.0121.71*	Abstandhalter Ø 15mm mit flachem Kopf und Kunststoff-Unterlagsscheiben <i>entretoise Ø 15mm avec tête plate et rondelles en mat. plastique</i>	2 x 4mm (8.0)	10mm	18.5mm	
	20	79.015.0125.71*	Abstandhalter Ø 15mm mit flachem, schraubbarem Kopf <i>entretoise Ø 15mm avec tête à vis, plate</i>	1 - 12mm	9 - 10mm	20mm	
	8	79.025.0115.71*	Abstandhalter Ø 25mm mit flachem, schraubbarem Kopf, inkl. 2 Stk. Kunststoff-Unterlagsscheiben für Glasschutz <i>entretoise Ø 25mm avec tête à vis, plate, 2 pièces du rondelles en mat. plastique pour protection du verre</i>	1 - 17mm	10 - 12mm	25mm	
	4	79.040.0135.71*	Abstandhalter Ø 40mm mit flachem, schraubbarem Kopf <i>entretoise Ø 40mm avec tête à vis, plate</i>	3 - 22mm	16 - 18mm	40mm	

*Ab Lager lieferbar

*livrable du stock









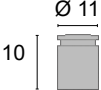

.71 = Edelstahl V2A

.71 = acier inoxydable V2A

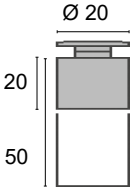
KELLER - Abstandhalter K-fix

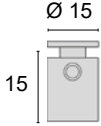
KELLER - Fixations K-fix

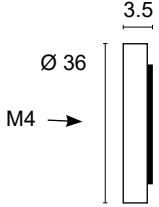
E 9

Abbildung dessin	VE unité	Artikelnummer no. d' article	Artikelbezeichnung description	Mat. Stärke épais. du mat.	Bohrung Ø perçage Ø	Wandabstand dist. mural	
	20 20	79.011.1024.71* 79.011.1058.71*	Abstandhalter Ø 11mm mit flachem Kopf, Linksgewinde , Unterteil mit Kragen	2 - 4mm 5 - 8mm	9mm 9mm	10mm 10mm	
			<i>entretoise Ø 11mm avec tête plate, vis à gauche, partie inférieure avec col</i>				
	20	79.014.1338.71*	Abstandhalter Ø 13.5mm mit flachem schraubbarem Kopf, Linksgewinde , Unterteil mit Kragen	3 - 10mm	11mm	13mm	
			<i>entretoise Ø 13.5mm avec tête plate, vis à gauche, partie inférieure avec col</i>				
	8 8	79.020.2031.71* 79.020.5031.71	Abstandhalter Ø 20mm mit flachem Kopf, Linksgewinde , Unterteil mit Kragen	3 - 18mm 3 - 18mm	11 - 14mm 11 - 14mm	20mm 50mm	
			<i>entretoise Ø 20mm avec tête plate, vis à gauche, partie inférieure avec col</i>				
	20	79.015.0404.73	Abstandhalter Ø 15mm mit flachem Kopf, Sicherung mit seitlicher Imbusschraube, Unterteil ohne Kragen, inkl. 2 Stk. Gummi- scheiben für Glasschutz	3 - 12mm	8 - 9mm	15mm	
			<i>entretoise Ø 15mm avec tête plate, protection avec vis latérale, partie inférieure sans col, 2 pièces de caoutchouc incluses pour protection du verre</i>				
	20	79.036.1525.71*	Abstandhalter-Rosette für Glas- montage mit M4-Gewin- de / rückseitig mit Klebepunkt				
			<i>rosace pour entretoise à coller (montage sur verse) avec taraud M4, verso avec rondelle à coller double-face</i>				
							

*Ab Lager lieferbar











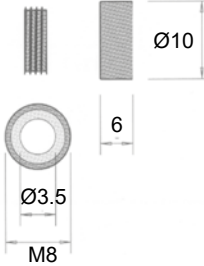

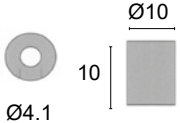
*livrable du stock

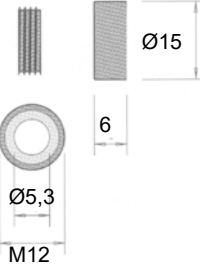
.71 = Edelstahl V2A
.73 = Edelstahl V4A

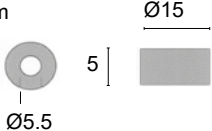
.71 = acier inoxydable V2A
.73 = acier inoxydable V4A

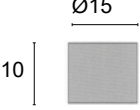
KELLER - Abstandhalter K-fix
KELLER - Fixations K-fix

E 9

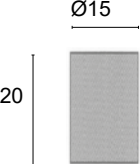
Abbildung dessin	VE unité	Artikelnummer no. d' article	Artikelbezeichnung description	Bohrung Ø perçage Ø	Wandabstand dist. mural	
	20	79.010.0353.71*	Zierkappe Ø 10mm, mit Gewindehülse, flachem Kopf, Linksgewinde <i>capuchon décoratif Ø 10mm,</i> <i>avec tête plate, vis à gauche et</i> <i>douille filetée à vis</i>	5mm		
	20	79.010.0367.71*	Distanzring Ø 10mm <i>bague d'écartement Ø 10mm</i>	10mm	10mm	
	20	79.015.0354.71*	Zierkappe Ø 15mm, mit Gewindehülse, flachem Kopf, Linksgewinde <i>capuchon décoratif Ø 15mm,</i> <i>avec tête plate, vis à gauche et</i> <i>douille filetée à vis</i>	5mm		
	20	79.015.0378.71	Distanzring Ø 15mm <i>bague d'écartement Ø 15mm</i>	4 - 10mm	5mm	
	20	79.015.0379.71*	Distanzring Ø 15mm <i>bague d'écartement Ø 15mm</i>	4 - 10mm	10mm	
	20	79.015.0380.71	Distanzring Ø 15mm <i>bague d'écartement Ø 15mm</i>	4 - 10mm	15mm	
	20	79.015.0381.71	Distanzring Ø 15mm <i>bague d'écartement Ø 15mm</i>	4 - 10mm	20mm	

*Ab Lager lieferbar

*livrable du stock

.71 = Edelstahl V2A

.71 = acier inoxydable V2A

KELLER - Abstandhalter K-fix

KELLER - Fixations K-fix

E 9

Abbildung dessin	VE unité	Artikelnummer no. d' article	Artikelbezeichnung description	Ø	Wandabstand distance mural	
	20	79.013.0533.71	Distanzhalter dezent und unsichtbar für Montage von Platten Logos, Buchstaben (> 18mm Materialstärke) mit Abständen von 20 - 50mm für den Innen- und Aussenraum	13mm	20mm	
	20	79.013.0534.71	Abständen von 20 - 50mm für den Innen- und Aussenraum	13mm	30mm	
	20	79.013.0535.71	<i>entretoise</i> <i>délicate et invisible pour un mon-</i> <i>tage des plaques, des logos, des</i>	13mm	40mm	
	20	79.013.0536.71	<i>lettres (> 18mm épaisseur du mat.)</i> <i>avec des distances du 20 - 50mm</i> <i>pour l'intérieur et extérieur</i>	13mm	50mm	
						



Distanzhalter

zur schnellen Montage von Logos,
Fassadentexten, Fräsbuchstaben
und Schildern mit Spezial-Kleb-
stoff (Material Kunststoff weiss /
transparent hellblau)

entretoise
pour un montage fixe du logo, des
textes de la façade, des lettres
du fraisage et des plaques avec
des colles spéciales (matériau en
plastique blanc / transparent bleu
clair)

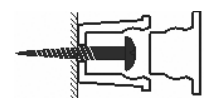

**mit Flachkopf-
schraube montieren**
monter avec vis à
tête conique

100	79.012.1207.00	Nur im Innenbereich verwenden <i>usage intérieur uniquement</i>	12mm	7mm
100	79.016.1615.00	bis 250mm Versalhöhe <i>hauteur versal jusqu'à 250mm</i>	16mm	15mm
100	79.017.1720.00	bis 400mm Versalhöhe <i>hauteur versal jusqu'à 400mm</i>	17mm	20mm
100	79.020.2024.00	über 400mm Versalhöhe <i>hauteur versal jusqu'après de 400mm</i>	20mm	24mm

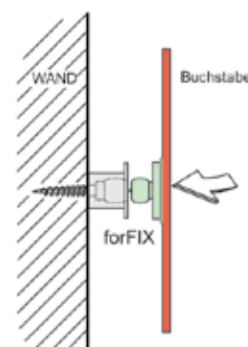

*Ab Lager lieferbar

.00 = Kunststoff weiss
.71 = Edelstahl V2A

*livrable du stock

.00 = mat. plastique blanc
.71 = acier inoxydable V2A

KELLER - Plattenhalter K-fix

KELLER - Fixations de plaque K-fix

E 9

Abbildung dessin	VE unité	Artikelnummer no. d' article	Artikelbezeichnung description	Mat. Stärke épais. du mat.	Bohrung Ø perçage Ø	Wandabstand dist. mural	
	20	79.020.0319.71	Plattenhalter Ø 20mm <i>fixation de plaque Ø 20mm</i>	1 - 6mm		20mm	
	20	79.020.0310.71	Spiegelhalter Ø 20mm <i>fixation de verre Ø 20mm</i>	4 / 6 / 8mm		15mm	
	20	79.015.0339.77	Glasbodenhalter 15x15mm Sicherung mit Madenschraube mit Kunststoffaufsatz <i>fixation de plaque en verre 15x15mm</i> <i>sécurité avec vis en matière</i> <i>plastique</i>	4 - 10mm	3.2mm		
	20	79.020.0460.71	Plattenhalter Ø 20mm <i>fixation de plaque Ø 20mm</i>	3 - 10mm	5mm	5mm	







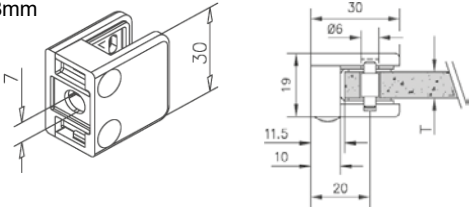

*Ab Lager lieferbar

*livrable du stock

.71 = Edelstahl V2A
.77 = Messing verchromt poliert

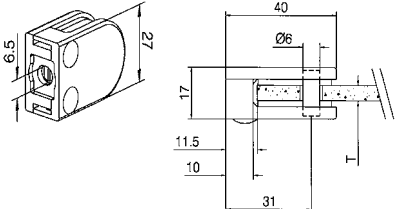
.71 = acier inoxydable V2A
.77 = laiton chromé poli

KELLER - Glasklemmen K-fix
KELLER - pinces à verre K-fix

Abbildung dessin	VE unité	Artikelnummer no. d' article	Artikelbezeichnung description	Mat.stärke (T) épais. du mat. (T)	Ø	techn. Abbildung illustration technique
	4	57.000.2300.44 .71	Glasklemme flach ohne Gummieinlagen <i>pince à verre plate</i> <i>sans cale caoutchouc</i>	6mm / 8mm		
		4	57.025.2300.44 .71	Glasklemme für Rohr ohne Gummieinlagen <i>pince à verre pour tube</i> <i>sans cale caoutchouc</i>	6mm / 8mm	25.4 - 30.0
	4	57.038.2300.44 .71		6mm / 8mm	38.1 - 42.4	
	8	57.006.5016.86	Gummieinlage <i>cale caoutchouc</i>	6mm		
	8	57.008.5016.86		8mm		
	4	57.000.2700.44* .71	Glasklemme flach ohne Gummieinlagen <i>pince à verre plate</i> <i>sans cale caoutchouc</i>	6mm / 8mm		
		4	57.025.2700.44 .71	Glasklemme für Rohr ohne Gummieinlagen <i>pince à verre pour tube</i> <i>sans cale caoutchouc</i>	6mm / 8mm	25.4 - 30.0
	4	57.038.2700.44 .71		6mm / 8mm	38.1 - 42.4	
	8	57.006.5012.86	Gummieinlage <i>cale caoutchouc</i>	6mm		
	8	57.008.5012.86		8mm		
	4	57.014.5015.73	Sicherungsstift für Glasklemme <i>goupille de sécurité pour pince à verre</i>			

Massangaben sind unverbindlich.

Les indications de mesure n'engagent à rien.

*Ab Lager lieferbar

*livrable du stock



.44 = Edelstahl-Design
.71 = Edelstahl V2A
.73 = Edelstahl V4A

.86 = Kunststoff schwarz

.44 = design acier inoxydable .86 = matière plastique noire
.71 = acier inoxydable V2A
.73 = acier inoxydable V4A

KELLER - Plattenhalter K-fix
KELLER - fixation de plaque K-fix

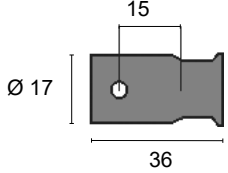
E 9

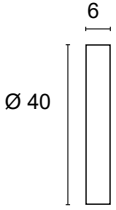
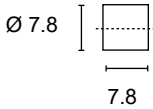
Abbildung dessin	VE unité	Artikelnummer no. d' article	Artikelbezeichnung description	Mat. Stärke épais. du mat.	Bohrung Ø perçage Ø
	8	79.017.1736.71*	Fahnenhalter Ø 17mm <i>fixation saillante Ø 17mm</i>	2 - 8mm	4 - 6mm
					
	8	79.040.4050.71*	Stabilisationsrosette Ø 40mm für Fahnen- / Deckenhalter <i>rosace de fixation Ø 40mm pour supports saillants ou suspension</i>		
					
	20	79.008.7878.71	Zusatzhülse Ø 7.8mm wenn aus fertigungstechnischen Gründen die Schildbohrung grösser als 4 - 5mm sein muss <i>douille supplement Ø 7.8mm si le perçage doit être plus grand que 4 - 5mm pour raisons de fabri- cation technique</i>		
					

*Ab Lager lieferbar

.71 = Edelstahl V2A

*livrable du stock

.71 = acier inoxydable V2A

Abbildung dessin	VE unité	Artikelnummer no. d' article	Artikelbezeichnung description	Mat.stärke épais. du mat.
---------------------	-------------	---------------------------------	-----------------------------------	------------------------------

Die KELLER-Deckenabhängungen K-fix für Verkaufsräume, Messestände etc. sind universell und im Detail durchdacht. Sie eignen sich für verschiedene Plattenstärken. An der Deckenautomatik ist ein A) selbstarretierender Stift oder B) eine Rändelmutter montiert. Das Seil (1.2 - 1.5mm) kürzen Sie wo es nötig ist - mit dem doppelseitigen Plattenhalter können mehrere Schilder untereinandergehängt werden.

Nos systèmes de suspension KELLER K-fix dans des salles de ventes, foires etc. sont universelles et sophistiqués. A) Un goupille autobloquant ou B) un écrou moleté est monté à la fixation automatique. Adaptées à différentes épaisseurs de panneau, la longueur de leurs câbles (1.2 - 1.5mm) peut être réglée au dernier moment à la longueur souhaitée. Plusieurs panneaux peuvent être suspendus un sous l'autre avec les fixations double K-fix.

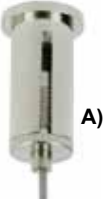
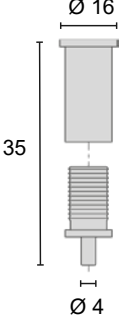
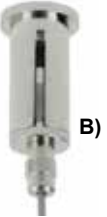
	8	79.016.0514.38*	Deckenautomatik, Ø 16mm mit Hülse, Traglast: ca. 20kg <i>fixation automatique de plafond avec douille, Ø 16mm, charge suspendue : ca. 20kg</i>	max. Ø 1.5mm	
	8	79.016.0517.38*	Deckenautomatik Ø 16mm mit Hülse und Sicherung, Traglast: 20 kg <i>fixation automatique de plafond avec douille et sécurité, Ø 16mm, charge suspendue: 20kg</i>	max. Ø 1.5mm	

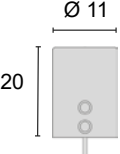
	8	79.011.0334.71*	Deckenhalter Ø 11mm für Seilstärke: 1.5 - 2mm <i>fixation de plafond Ø 11mm pour épaisseur de câble: 1.5 - 2mm</i>		
---	---	-----------------	---	--	---

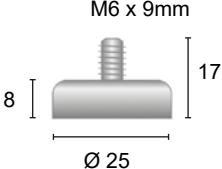
	8	79.025.0636.41*	Deckenmagnet Ø 25mm Traglast: 22kg <i>aiment p. plafond Ø 25mm charge suspendue: 22 kg</i>		
---	---	-----------------	---	--	---



*Ab Lager lieferbar

*livrable du stock

.38 = Messing vernickelt
 .41 = Stahl vernickelt
 .71 = Edelstahl V2A

.38 = laiton nickelé
 .41 = acier nickelé
 .71 = acier inoxydable V2A











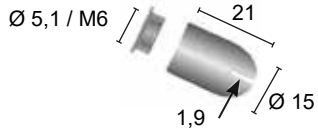



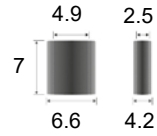

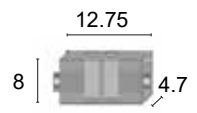
Abbildung dessin	VE unité	Artikelnummer no. d' article	Artikelbezeichnung description	Mat.stärke épais. du mat.
	8	79.015.0642.41*	Deckenhalter Ø 15mm für Schrägdach mit Gewindehülse für Seilstärke: 1,2 - 1,5mm mit Kugel Traglast: 20kg <i>fixation de plafond incliné Ø 15mm avec douille pour épaisseur de câble: 1,2 - 1,5mm avec boule charge suspendu: 20kg</i>	
 				
	250mtr.	79.056.0260.73*	Edelstahlseil V4A, Ø 1.5mm <i>câble en acier inox V4A, Ø 1.5mm</i>	
	20	79.001.8005.00	Presshülse aus ALU für Edelstahlseil Ø 1.5 - 2mm <i>douille de serrage en alu pour câble en acier inoxydable Ø 1.5 - 2mm</i>	
				
	20	79.432.0352.00	Seilklemme aus ALU für Edelstahlseil Ø 1 - 2mm <i>pince à corde en alu pour câble en acier inoxydable Ø 1 - 2mm</i>	
				
			Edelstahlseil V2A, Ø 1.5mm mit Kugelkopf Ø 5mm <i>câble en acier inox V2A, Ø 1.5mm avec tête ronde Ø 5mm</i>	
	20	79.044.8009.71	Länge / longueur 750mm	
	20	79.044.8010.71	1000mm	
	20	79.044.8011.71*	1500mm	
	20	79.044.8012.71	2000mm	
	20	78.044.8013.71	3000mm	
*Ab Lager lieferbar			*livrable du stock	
.38 = Messing vernickelt				.38 = laiton nickelé
.41 = Stahl vernickelt				.41 = acier nickelé
.71 = Edelstahl V2A		.73 = Edelstahl V4A		.71 = acier inoxydable V2A .73 = acier inoxydable V4A

Abbildung dessin	VE unité	Artikelnummer no. d' article	Artikelbezeichnung description	Mat.stärke épais. du mat.	Bohrung Ø perçage Ø
 	8	79.011.0333.71*	Plattenhalter Ø 11mm für Seilstärke: 1,5 - 2mm, Fixierung mit seitlichen Madenschrauben <i>fixation de plaque Ø 11mm pour épaisseur de câble: 1,5 - 2mm, fixation avec des vis de serrage</i>	3 - 6mm	
	8	79.018.0558.71*	Plattenhalter Ø 18mm für Seilstärke: 1.5 - 2mm, Fixierung mit seitlichen Madenschrauben, Traglast: ca. 30kg <i>fixation de plaque Ø 18mm pour épaisseur de câble: 1.5 - 2mm, fixation avec des vis de serrage, charge suspendue ca. 30kg</i>	1 - 10mm	5 - 8mm
					
				a) M5 x 10mm für Platten 3-10mm ohne Loch M5 x 10mm pour plaque 3-10mm sans trous	b) M5 x 16mm für Platte 1-10mm mit Loch M5 x 16mm pour plaque 1-10mm avec trous
	8	79.018.0555.71	Plattenhalter Ø 18mm für Seilstärke: 1.5mm, Fixierung durch Seilautomatik mit selbststarretie- rendem Stift, Traglast: ca. 20kg <i>fixation de plaque Ø 18mm pour épaisseur de câble: 1.5mm, fixation avec corde automatique autobloquante, charge suspendue ca. 20kg</i>	1 - 10mm	3 - 8mm
					
				a) M5 x 10mm für Platte 3-10mm ohne Loch M5 x 10mm pour plaque 3-10mm sans trous	b) M5 x 16mm für Platte 1-10mm mit Loch M5 x 16mm pour plaque 1-10mm avec trous

*Ab Lager lieferbar

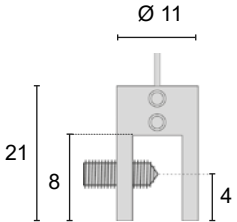
*livrable du stock

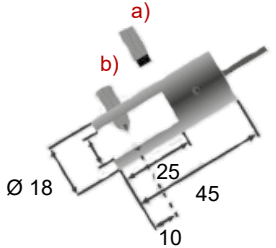
.71 = Edelstahl V2A

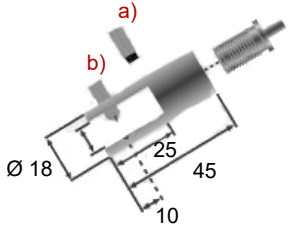
.71 = acier inoxydable V2A

Abbildung dessin	VE unité	Artikelnummer no. d' article	Artikelbezeichnung description	Mat.stärke épais. du mat.	Bohrung Ø perçage Ø
---------------------	-------------	---------------------------------	-----------------------------------	------------------------------	------------------------



8 79.017.1734.71* **Plattenhalter Ø 17mm**
fixation de plaque Ø 17mm

2 - 8mm 2 - 8mm

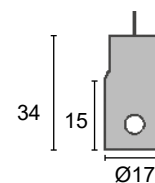

8 79.017.0409.41* **Aufhänge-Haken Ø 17mm**
 Hängelast ca. 15 kg

patère Ø 17mm
charge suspendue ca. 15 kg

1.5mm

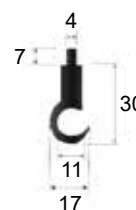

20 79.008.7878.71 **Zusatzhülse Ø 7.8mm**
 wenn aus fertigungstechnischen
 Gründen die Schildbohrung grösser
 als 4 - 5mm sein muss

douille supplement Ø 7.8mm
si le perçage doit être plus grand
que 4 - 5mm pour raisons de fabri-
cation technique

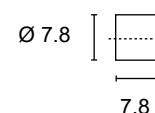

20 79.015.3769.71* **Plattenverbinder Ø 15mm**
raccord de plaque Ø 15mm

8 - 10mm 11mm

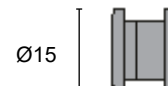

*Ab Lager lieferbar

*livrable du stock





.41 = Stahl vernickelt
 .71 = Edelstahl V2A

.41 = acier nickelé
 .71 = acier inoxydable V2A

KELLER - Prospekthalter K-fix

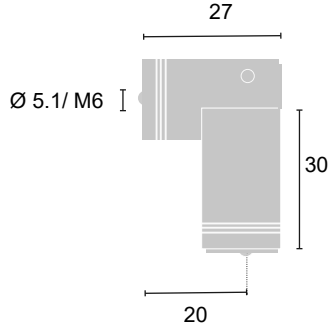
KELLER - fixation de prospectus K-fix

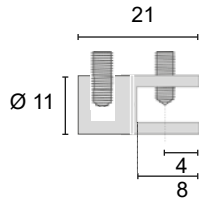
E 9

Abbildung dessin	VE unité	Artikelnummer no. d' article	Artikelbezeichnung description	Mat.stärke épais. du mat.	Aussenmass B x H dim. d'extérieur L x H	DIN DIN
	8	79.018.6018.71	Gelenkhalter bis 90°, Ø 18mm mit integrierter Spannfunction <i>fixation d'articulation jusqu'à 90°, Ø 18mm, avec fonction de tension intégrée</i>			
			Edelstahlseil V2A, Ø 1.5mm mit Kugelkopf Ø 5mm <i>câble en acier inox V2A, Ø 1.5mm avec tête ronde Ø 5mm</i>			
	20	79.044.8009.71	Länge / longueur	750mm		
	20	79.044.8010.71		1000mm		
	20	79.044.8011.71*		1500mm		
	20	79.044.8012.71		2000mm		
	20	78.044.8013.71		3000mm		
	8	79.012.0603.71	Plattenhalter Ø11mm 3 - 6mm für Seilstärke: 1,5 - 2mm, Fixierung mit seitlichen Madenschrauben <i>fixation de plaque Ø 11mm pour épaisseur de câble: 1,5 - 2mm fixation avec des vis de serrage</i>			
	8	79.018.6018.71	Gelenkhalter, dito <i>fixation d'articulation, dito</i>			



79.045.9905.87	Prospekthalter, Acryl	148.5 x 210.0mm	A5
79.045.9915.87	<i>fixation de prospectus</i>	210.0 x 148.5mm	A5
79.045.9904.87		210.0 x 297.0mm	A4
79.045.9914.87		297.0 x 210.0mm	A4

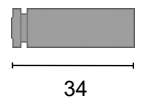

4	79.410.1034.71*	Prospekthalter (Set à 4 Stk. Halter + 2 Stk. Silikongummispanner) <i>fixation de prospectus (set à 4 pces fixations + 2 pces bandes à tension en silicone)</i>	Ø 10 
---	-----------------	--	--

*Ab Lager lieferbar

*livrable du stock

.71 = Edelstahl V2A
 .87 = Kunststoff transparent (Acryl)

.71 = acier inoxydable V2A
 .87 = mat. plastique transparent (acryl)

Abbildung dessin	VE unité	Artikelnummer no. d' article	Artikelbezeichnung description	Mat. Stärke épais. du mat.	Bohrung Ø perçage Ø
---------------------	-------------	---------------------------------	-----------------------------------	-------------------------------	------------------------



10 79.012.0561.71* Halter f. Tischaufsteller Ø 12mm 1 - 16mm
fixation de plaquette p. table Ø 12mm

5mm

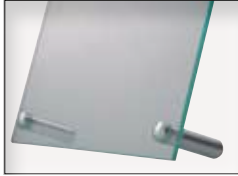
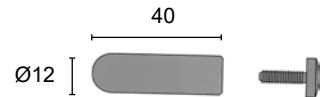

10 79.014.1460.71 Halter f. Tischaufsteller Ø 14mm 3 - 8mm
fixation de plaquette p. table Ø 14mm

11mm

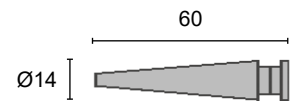

78.432.1575.11* Schild „Frei / Besetzt“
 rückseitig mit Doppelklebeband
 78.432.1576.11
*plaque „libre / occupé“
 bande double adhésive du revers*

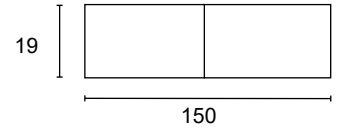

78.432.1579.11* Grundplatte zum Schrauben
 für Schild „Frei / Besetzt“
*plaque de base à visser pour
 plaque „libre / occupé“*

*Ab Lager lieferbar

*livrable du stock

.11 = Alu natur eloxiert
 .71 = Edelstahl V2A

.11 = alu anodisé naturel
 .71 = acier inoxydable V2A

Abbildung dessin	VE unité	Artikelnummer no. d' article	Artikelbezeichnung description	Mass B x H dim. L x H
---------------------	-------------	---------------------------------	-----------------------------------	--------------------------



20 79.010.0221.00
 20 79.015.0268.00

Scheibenmagnet
 Traglast: 1 kg

Ø 10 x 2mm
 Ø 15 x 2mm

aiment rond
charge suspendue: 1 kg



20 79.025.0606.41

Topfmagnet
 mit Innengewinde M5 x 8mm
 Traglast 15 kg

Ø 25 x 8mm

aiment de pot
avec filetage intérieur M5 x 8mm
charge suspendue: 15kg

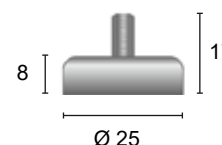

20 79.025.0636.41*

Deckenmagnet
 mit Aussengewinde M6 x 9mm
 Traglast: 22kg

Ø 25 x 8mm

aiment p. plafond
avec filetage extérieur M6 x 9mm
charge suspendue: 22 kg

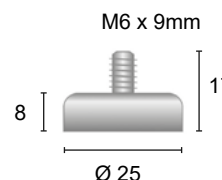

78.045.0610.87 **Haftsauger**
 ventouse

Ø 50mm

*Ab Lager lieferbar

*livrable du stock

.00 = roh
 .41 = Stahl vernickelt
 .87 = Kunststoff transparent

.00 = brut
 .41 = acier nickelé
 .87 = mat. plastique transp.

Auszug aus unserem Lieferprogramm

Extrait de notre gamme de produits



Stelen und Pylone outdoor

Stèles et pylônes outdoor



Leit- und Orientierungssystem indoor

Systèmes signalétiques indoor



Werbe- und Spannrahmensysteme

Systèmes publicités et cadres de tension



Mitteilungs- und Informationsvitrinen, Innen-Vitrinen

Panneaux d'information et d'affichage, vitrines d'intérieur



Fahnenmasten

Mâts de drapeaux